



PMBT2222; PMBT2222A

NPN switching transistors

Rev. 6 — 12 November 2010

Product data sheet

1. Product profile

1.1 General description

NPN switching transistors in a small SOT23 (TO-236AB) Surface-Mounted Device (SMD) plastic package.

Table 1. Product overview

Type number	Package		PNP complement
	Nexperia	JEDEC	
PMBT2222	SOT23	TO-236AB	PMBT2907
PMBT2222A			PMBT2907A

1.2 Features and benefits

- High current (max. 600 mA)
- Low voltage (max. 40 V)

1.3 Applications

- Switching and linear amplification

1.4 Quick reference data

Table 2. Quick reference data

Symbol	Parameter	Conditions	Min	Typ	Max	Unit
V_{CE0}	collector-emitter voltage	open base				
	PMBT2222		-	-	30	V
	PMBT2222A		-	-	40	V
I_C	collector current		-	-	600	mA
h_{FE}	DC current gain	$V_{CE} = 10\text{ V};$ $I_C = 150\text{ mA}$	[1] 100	-	300	
	PMBT2222	$V_{CE} = 10\text{ V};$ $I_C = 500\text{ mA}$	[1] 30	-	-	
	PMBT2222A	$V_{CE} = 10\text{ V};$ $I_C = 500\text{ mA}$	[1] 40	-	-	

[1] Pulse test: $t_p \leq 300\text{ }\mu\text{s}; \delta \leq 0.02$.

2. Pinning information

Table 3. Pinning

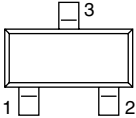
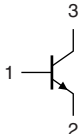
Pin	Description	Simplified outline	Graphic symbol
1	base		
2	emitter		
3	collector		

sym021

3. Ordering information

Table 4. Ordering information

Type number	Package		
	Name	Description	Version
PMBT2222	-	plastic surface-mounted package; 3 leads	SOT23
PMBT2222A			

4. Marking

Table 5. Marking codes

Type number	Marking code ^[1]
PMBT2222	*1B
PMBT2222A	*1P

[1] * = placeholder for manufacturing site code

5. Limiting values

Table 6. Limiting values

In accordance with the Absolute Maximum Rating System (IEC 60134).

Symbol	Parameter	Conditions	Min	Max	Unit
V _{CBO}	collector-base voltage	open emitter			
	PMBT2222		-	60	V
	PMBT2222A		-	75	V
V _{CEO}	collector-emitter voltage	open base			
	PMBT2222		-	30	V
	PMBT2222A		-	40	V
V _{EBO}	emitter-base voltage	open collector			
	PMBT2222		-	5	V
	PMBT2222A		-	6	V
I _C	collector current		-	600	mA
I _{CM}	peak collector current		-	800	mA
I _{BM}	peak base current		-	200	mA
P _{tot}	total power dissipation	T _{amb} ≤ 25 °C	[1] -	250	mW
T _j	junction temperature		-	150	°C
T _{amb}	ambient temperature		-65	+150	°C
T _{stg}	storage temperature		-65	+150	°C

[1] Device mounted on an FR4 Printed-Circuit Board (PCB), single-sided copper, tin-plated and standard footprint.

6. Thermal characteristics

Table 7. Thermal characteristics

Symbol	Parameter	Conditions	Min	Typ	Max	Unit
R _{th(j-a)}	thermal resistance from junction to ambient	in free air	[1] -	-	500	K/W

[1] Device mounted on an FR4 PCB, single-sided copper, tin-plated and standard footprint.

7. Characteristics

Table 8. Characteristics

$T_j = 25\text{ °C}$ unless otherwise specified.

Symbol	Parameter	Conditions	Min	Typ	Max	Unit	
I_{CBO}	collector-base cut-off current	PMBT2222	$V_{CB} = 50\text{ V}; I_E = 0\text{ A}$	-	-	10	nA
			$V_{CB} = 50\text{ V}; I_E = 0\text{ A}; T_j = 125\text{ °C}$	-	-	10	μA
	collector-base cut-off current	PMBT2222A	$V_{CB} = 60\text{ V}; I_E = 0\text{ A}$	-	-	10	nA
			$V_{CB} = 60\text{ V}; I_E = 0\text{ A}; T_j = 125\text{ °C}$	-	-	10	μA
I_{EBO}	emitter-base cut-off current	$V_{EB} = 5\text{ V}; I_C = 0\text{ A}$	-	-	10	nA	
h_{FE}	DC current gain		$V_{CE} = 10\text{ V}; I_C = 0.1\text{ mA}$	35			
			$V_{CE} = 10\text{ V}; I_C = 1\text{ mA}$	50	-	-	
			$V_{CE} = 10\text{ V}; I_C = 10\text{ mA}$	75	-	-	
			$V_{CE} = 10\text{ V}; I_C = 10\text{ mA}; T_{amb} = -55\text{ °C}$	35	-	-	
			$V_{CE} = 10\text{ V}; I_C = 150\text{ mA}$	[1] 100	-	300	
			$V_{CE} = 1\text{ V}; I_C = 150\text{ mA}$	[1] 50	-	-	
	DC current gain		$V_{CE} = 10\text{ V}; I_C = 500\text{ mA}$	[1]			
		PMBT2222		30	-	-	
		PMBT2222A		40	-	-	
V_{CEsat}	collector-emitter saturation voltage		$I_C = 150\text{ mA}; I_B = 15\text{ mA}$	[1]			
		PMBT2222		-	-	400	mV
	PMBT2222A		-	-	300	mV	
	collector-emitter saturation voltage		$I_C = 500\text{ mA}; I_B = 50\text{ mA}$	[1]			
		PMBT2222		-	-	1.6	V
		PMBT2222A		-	-	1	V

Table 8. Characteristics ...continued $T_j = 25\text{ °C}$ unless otherwise specified.

Symbol	Parameter	Conditions	Min	Typ	Max	Unit	
V_{BEsat}	base-emitter saturation voltage	$I_C = 150\text{ mA};$ $I_B = 15\text{ mA}$	[1]				
			PMBT2222	-	-	1.3	V
	PMBT2222A	0.6	-	1.2	V		
	base-emitter saturation voltage	$I_C = 500\text{ mA};$ $I_B = 50\text{ mA}$	[1]				
			PMBT2222	-	-	2.6	V
	PMBT2222A	-	-	2	V		
C_c	collector capacitance	$V_{CB} = 10\text{ V};$ $I_E = i_e = 0\text{ A};$ $f = 1\text{ MHz}$	-	-	8	pF	
C_e	emitter capacitance	$V_{EB} = 500\text{ mV};$ $I_C = i_c = 0\text{ A};$ $f = 1\text{ MHz}$					
			PMBT2222	-	-	30	pF
			PMBT2222A	-	-	25	pF
f_T	transition frequency	$V_{CE} = 20\text{ V};$ $I_C = 20\text{ mA};$ $f = 100\text{ MHz}$					
			PMBT2222	250	-	-	MHz
			PMBT2222A	300	-	-	MHz
NF	noise figure	$V_{CE} = 5\text{ V};$ $I_C = 100\text{ }\mu\text{A};$ $R_S = 1\text{ k}\Omega;$ $f = 1\text{ kHz}$	-	-	4	dB	
t_d	delay time	$V_{CC} = 10\text{ V};$	-	-	15	ns	
t_r	rise time	$I_C = 150\text{ mA};$	-	-	20	ns	
t_{on}	turn-on time	$I_{Bon} = 15\text{ mA};$	-	-	35	ns	
t_s	storage time	$I_{Boff} = -15\text{ mA}$	-	-	200	ns	
t_f	fall time		-	-	60	ns	
t_{off}	turn-off time		-	-	250	ns	

[1] Pulse test: $t_p \leq 300\text{ }\mu\text{s}; \delta \leq 0.02$.

8. Test information

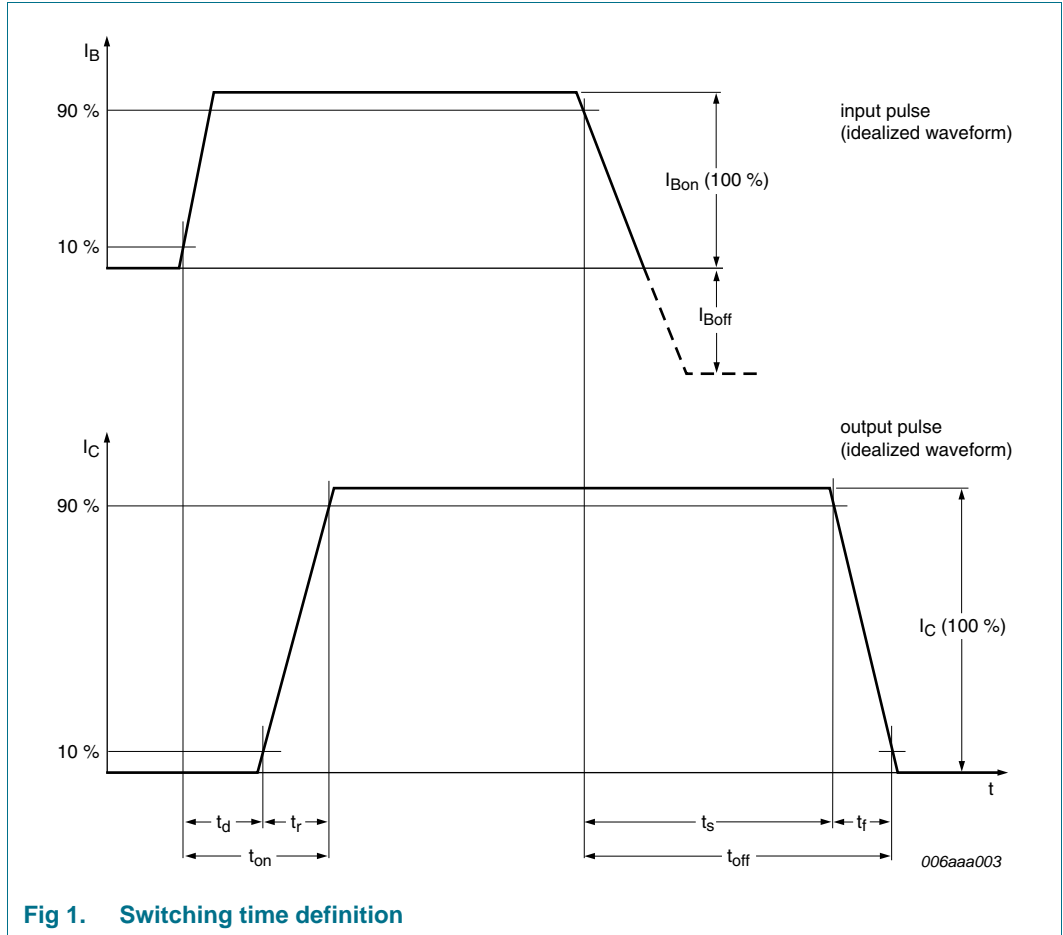

Fig 1. Switching time definition

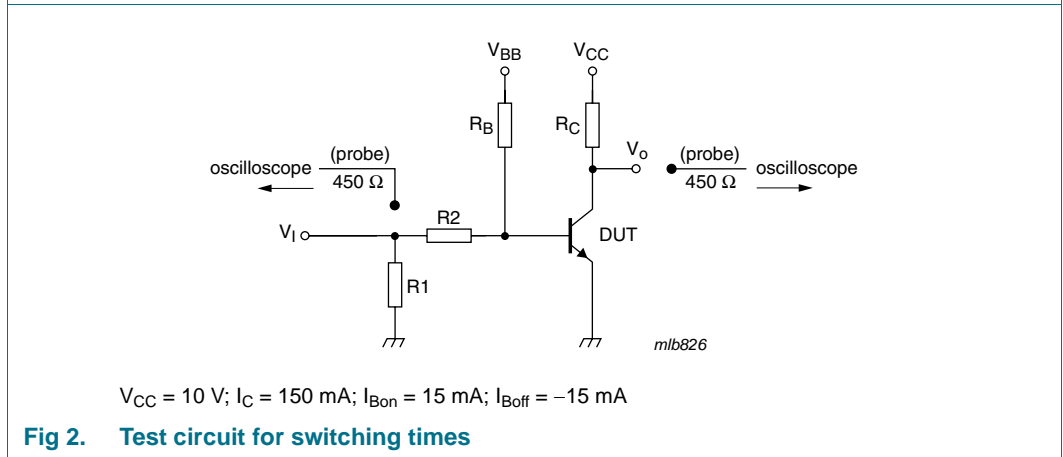
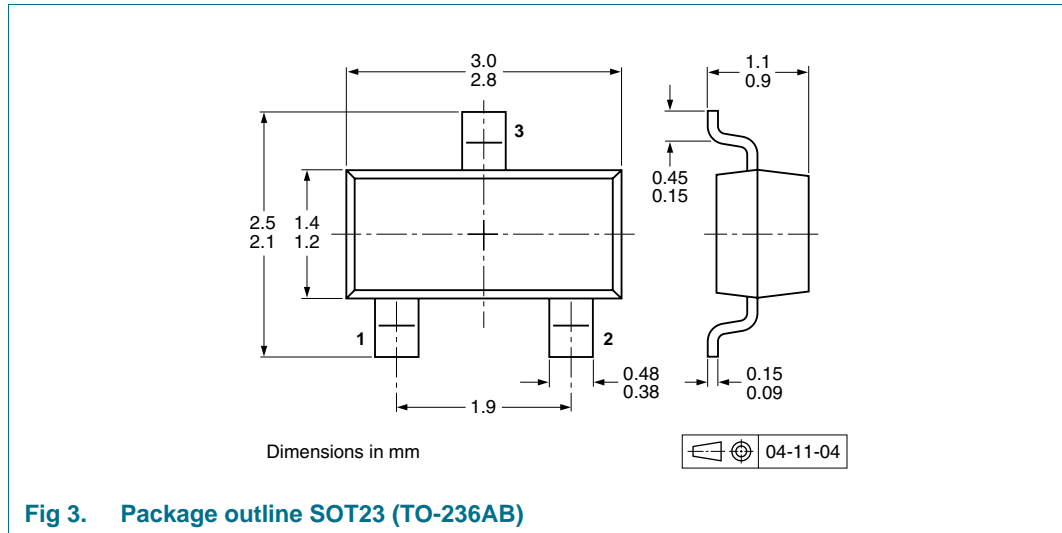

Fig 2. Test circuit for switching times

8.1 Quality information

This product has been qualified in accordance with the Automotive Electronics Council (AEC) standard Q101 - Stress test qualification for discrete semiconductors, and is suitable for use in automotive applications.

9. Package outline



10. Packing information

Table 9. Packing methods

The indicated -xxx are the last three digits of the 12NC ordering code.^[1]

Type number	Package	Description	Packing quantity	
			3000	10000
PMBT2222	SOT23	4 mm pitch, 8 mm tape and reel	-215	-235
PMBT2222A				

[1] For further information and the availability of packing methods, see [Section 14](#).

11. Soldering

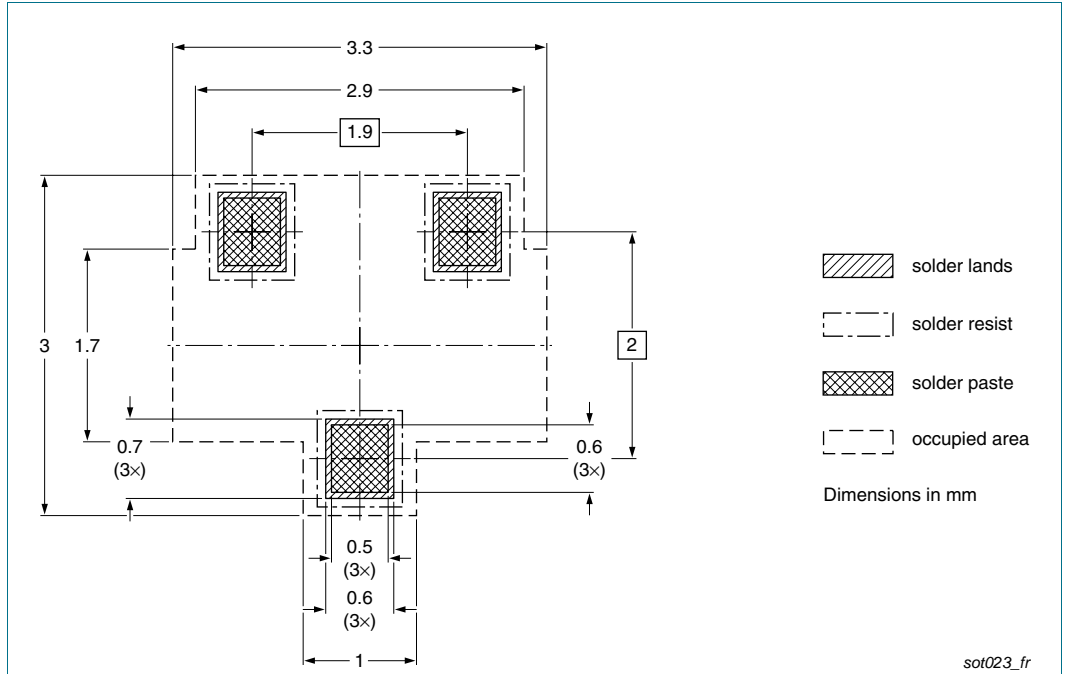

Fig 4. Reflow soldering footprint SOT23 (TO-236AB)

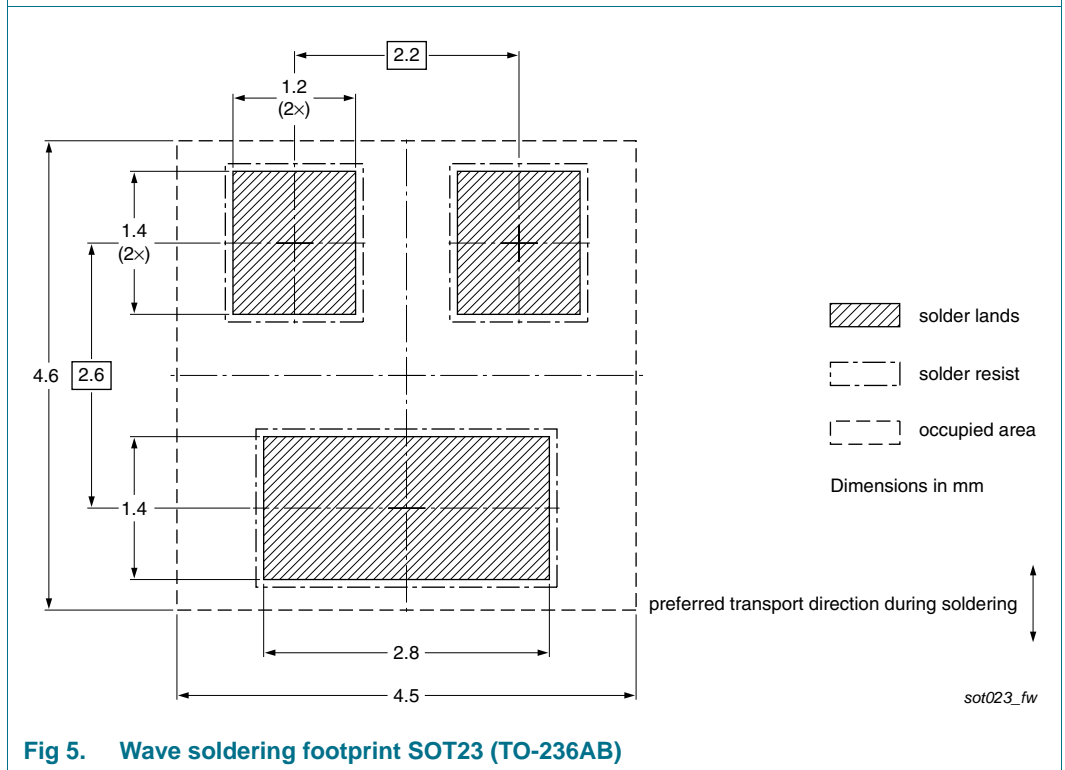

Fig 5. Wave soldering footprint SOT23 (TO-236AB)

12. Revision history

Table 10. Revision history

Document ID	Release date	Data sheet status	Change notice	Supersedes
PMBT2222_PMBT2222A v.6	20101112	Product data sheet	-	PMBT2222_2222A_5
Modifications:		<ul style="list-style-type: none"> • Section 4 “Marking”: updated • Figure 1 “Switching time definition”: added • Section 8 “Test information”: updated • Section 10 “Packing information”: added • Section 11 “Soldering”: added • Section 13 “Legal information”: updated 		
PMBT2222_2222A_5	20040122	Product specification	-	PMBT2222_2222A_4
PMBT2222_2222A_4	19990427	Product specification	-	PMBT2222_3
PMBT2222_3	19970909	Product specification	-	-

13. Legal information

13.1 Data sheet status

Document status ^{[1][2]}	Product status ^[3]	Definition
Objective [short] data sheet	Development	This document contains data from the objective specification for product development.
Preliminary [short] data sheet	Qualification	This document contains data from the preliminary specification.
Product [short] data sheet	Production	This document contains the product specification.

[1] Please consult the most recently issued document before initiating or completing a design.

[2] The term 'short data sheet' is explained in section "Definitions".

[3] The product status of device(s) described in this document may have changed since this document was published and may differ in case of multiple devices. The latest product status information is available on the Internet at URL <http://www.nexperia.com>.

13.2 Definitions

Draft — The document is a draft version only. The content is still under internal review and subject to formal approval, which may result in modifications or additions. Nexperia does not give any representations or warranties as to the accuracy or completeness of information included herein and shall have no liability for the consequences of use of such information.

Short data sheet — A short data sheet is an extract from a full data sheet with the same product type number(s) and title. A short data sheet is intended for quick reference only and should not be relied upon to contain detailed and full information. For detailed and full information see the relevant full data sheet, which is available on request via the local Nexperia sales office. In case of any inconsistency or conflict with the short data sheet, the full data sheet shall prevail.

Product specification — The information and data provided in a Product data sheet shall define the specification of the product as agreed between Nexperia and its customer, unless Nexperia and customer have explicitly agreed otherwise in writing. In no event however, shall an agreement be valid in which the Nexperia product is deemed to offer functions and qualities beyond those described in the Product data sheet.

13.3 Disclaimers

Limited warranty and liability — Information in this document is believed to be accurate and reliable. However, Nexperia does not give any representations or warranties, expressed or implied, as to the accuracy or completeness of such information and shall have no liability for the consequences of use of such information.

In no event shall Nexperia be liable for any indirect, incidental, punitive, special or consequential damages (including - without limitation - lost profits, lost savings, business interruption, costs related to the removal or replacement of any products or rework charges) whether or not such damages are based on tort (including negligence), warranty, breach of contract or any other legal theory.

Notwithstanding any damages that customer might incur for any reason whatsoever, Nexperia's aggregate and cumulative liability towards customer for the products described herein shall be limited in accordance with the *Terms and conditions of commercial sale* of Nexperia.

Right to make changes — Nexperia reserves the right to make changes to information published in this document, including without limitation specifications and product descriptions, at any time and without notice. This document supersedes and replaces all information supplied prior to the publication hereof.

Suitability for use — Nexperia products are not designed, authorized or warranted to be suitable for use in life support, life-critical or safety-critical systems or equipment, nor in applications where failure or

malfunction of a Nexperia product can reasonably be expected to result in personal injury, death or severe property or environmental damage. Nexperia accepts no liability for inclusion and/or use of Nexperia products in such equipment or applications and therefore such inclusion and/or use is at the customer's own risk.

Applications — Applications that are described herein for any of these products are for illustrative purposes only. Nexperia makes no representation or warranty that such applications will be suitable for the specified use without further testing or modification.

Customers are responsible for the design and operation of their applications and products using Nexperia products, and Nexperia accepts no liability for any assistance with applications or customer product design. It is customer's sole responsibility to determine whether the Nexperia product is suitable and fit for the customer's applications and products planned, as well as for the planned application and use of customer's third party customer(s). Customers should provide appropriate design and operating safeguards to minimize the risks associated with their applications and products.

Nexperia does not accept any liability related to any default, damage, costs or problem which is based on any weakness or default in the customer's applications or products, or the application or use by customer's third party customer(s). Customer is responsible for doing all necessary testing for the customer's applications and products using Nexperia products in order to avoid a default of the applications and the products or of the application or use by customer's third party customer(s). Nexperia does not accept any liability in this respect.

Limiting values — Stress above one or more limiting values (as defined in the Absolute Maximum Ratings System of IEC 60134) will cause permanent damage to the device. Limiting values are stress ratings only and (proper) operation of the device at these or any other conditions above those given in the Recommended operating conditions section (if present) or the Characteristics sections of this document is not warranted. Constant or repeated exposure to limiting values will permanently and irreversibly affect the quality and reliability of the device.

Terms and conditions of commercial sale — Nexperia products are sold subject to the general terms and conditions of commercial sale, as published at <http://www.nexperia.com/profile/terms>, unless otherwise agreed in a valid written individual agreement. In case an individual agreement is concluded only the terms and conditions of the respective agreement shall apply. Nexperia hereby expressly objects to applying the customer's general terms and conditions with regard to the purchase of Nexperia products by customer.

No offer to sell or license — Nothing in this document may be interpreted or construed as an offer to sell products that is open for acceptance or the grant, conveyance or implication of any license under any copyrights, patents or other industrial or intellectual property rights.

Export control — This document as well as the item(s) described herein may be subject to export control regulations. Export might require a prior authorization from national authorities.

Quick reference data — The Quick reference data is an extract of the product data given in the Limiting values and Characteristics sections of this document, and as such is not complete, exhaustive or legally binding.

13.4 Trademarks

Notice: All referenced brands, product names, service names and trademarks are the property of their respective owners.

14. Contact information

For more information, please visit: <http://www.nexperia.com>

For sales office addresses, please send an email to: salesaddresses@nexperia.com

15. Contents

1	Product profile	1
1.1	General description	1
1.2	Features and benefits	1
1.3	Applications	1
1.4	Quick reference data	1
2	Pinning information	2
3	Ordering information	2
4	Marking	2
5	Limiting values	3
6	Thermal characteristics	3
7	Characteristics	4
8	Test information	6
8.1	Quality information	6
9	Package outline	7
10	Packing information	7
11	Soldering	8
12	Revision history	9
13	Legal information	10
13.1	Data sheet status	10
13.2	Definitions	10
13.3	Disclaimers	10
13.4	Trademarks	11
14	Contact information	11
15	Contents	12

Mouser Electronics

Authorized Distributor

Click to View Pricing, Inventory, Delivery & Lifecycle Information:

[Nexperia:](#)

[PMBT2222,235](#) [PMBT2222A,235](#) [PMBT2222A,215](#) [PMBT2222,215](#)